

where to fit your blinds – inside or outside the frame

Your blinds can be fitted inside the window frame ('inside fit') or on the outside of the window on the wall or architrave ('outside fit').

inside fit

Inside fit is the most common option chosen as it provides a clean look that is more aesthetically appealing than an outside fit. It does however allow some light to get past the outside edges of the blind. If desired this can be minimised by fitting the blind further back into the window frame.

Before deciding on an inside fit you need to ensure that the window frame is deep enough to fit the blind and brackets. A guide to the required window frame

blind type	reveal depth	blind fit
single roller blind	greater than 75mm	fully inside frame
	50 to 75mm	partially outside frame
dual roller blinds	greater than 130mm	fully inside frame without double brackets
	115 to 130mm	fully inside frame with double brackets
	75 to 115 mm	one blind will fit partially outside the frame
50mm venetian blind (wood or synthetic)	greater than 70mm	fully inside frame
	40 to 70mm	partially outside frame <i>Note: discuss the need for fascia returns with our sales team.</i>
25mm aluminium venetian blind	greater than 30mm	fully inside frame
vertical blind	greater than 100mm	fully inside frame
	between 75 to 100mm	vanes will sit partially outside the frame
	40 to 75mm	partially outside the frame <i>Note: discuss the need for extended brackets with our sales team.</i>

Check your windows for any obstacles that may impede the operation of a blind such as handles, latches or mullions (wood or aluminium vertical divider between windows). Be especially careful in the case of sliding doors.

outside fit

Outside fit is where the blind is fitted on the outside of the window frame on the wall or architrave. This option is less common however you may want to select this option based on the following:

1. A particular look you are trying to achieve
2. Blocks more light as the blind covers the full face of the window

3. The window frame is not deep enough to hold the blinds in the case of an inside fit
4. There are obstacles in the window frame that the blinds may hit e.g. mullion
5. The window itself is not a rectangular shape

how to get the right measurement

- take all measurements to the nearest millimetre – do not round any of your measurements
- take all measurements twice ensuring that you get the same result each time

measuring technique for inside fit roller blind

width measurement

- Measure the inside width of your window frame across the very top of the frame ('width') (see figure 1)
- Note this measurement down on the blind measuring sheet

drop measurement

- Measure the inside height of the window frame ('drop') (see figure 1)
- Note this down on the blind measuring sheet

Do not make any adjustments or deductions to these measurements



figure 1: measuring an inside fit roller blind

measuring technique for inside fit blind venetian and vertical blinds

width measurement

- Measure the inside width of your window frame across the very top of the frame ('width') (see figure 2)
- Note this measurement down on the blind measuring sheet

drop measurement

- Measure the inside height of the window frame ('drop') in three places – left, right and centre of the window frame (see figure 2)
- Note down the smallest measurement of the three on the blind measuring sheet

Do not make any adjustments or deductions to these measurements.

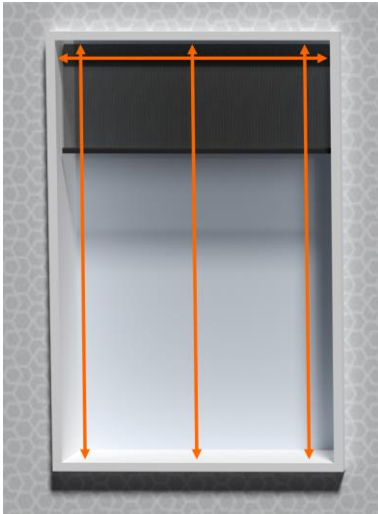

figure 2: measuring an inside fit venetian or vertical blind

measuring technique for an outside fit blind

Before measuring the window for an outside fit you need to decide how you are going to fit the blinds which will in part depend on the style of your window frames:

- If your windows do not have architraves then the blinds will generally be fitted to the wall above the window frame (so the screws can fix into the lintel behind your gib)
- If your windows have architraves you may either fix the blind brackets to the outside edges of the architraves or to the wall above the architraves

If you decide to fix the blind brackets to the architraves note that the width of the actual blind will be slightly less than the width of the architraves, hence some of the architrave will show when the blind is down / closed.

measuring outside fit – blind fixed to the wall

To measure an outside fit where the blind is to be fixed to the wall (i.e. above the window frame or architrave) carry out the following steps:

width measurement

- Measure the outside width of your window frame / architrave
- Add 70mm to your measurement (see figure 3)
- Note down the adjusted measurement on the blind measuring sheet

drop measurement

- Measure the outside height of your window frame / architrave
- Add 60mm to your measurement (see figure 3)
- Note down the adjusted measurement on the blind measuring sheet

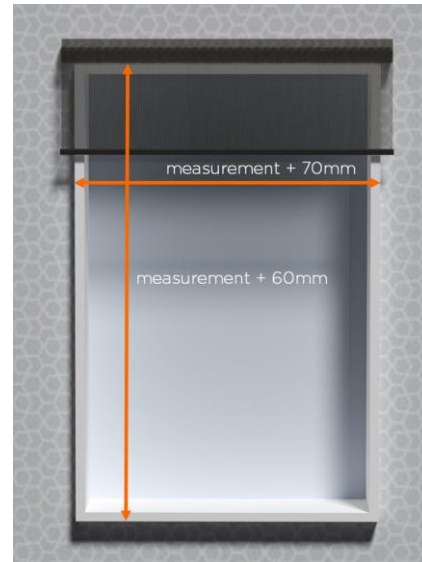

figure 3: measuring an outside fit blind – fixed to wall

measuring outside fit – blind fixed to the architrave

To measure an outside fit where the blind is to be fixed to the architrave, measure the outside width of the window architrave ('width') and the outside height of the architrave ('drop') (see figure 4).

Note these measurements down on the blind measuring sheet.

Do not make any adjustments or deductions to these measurements.

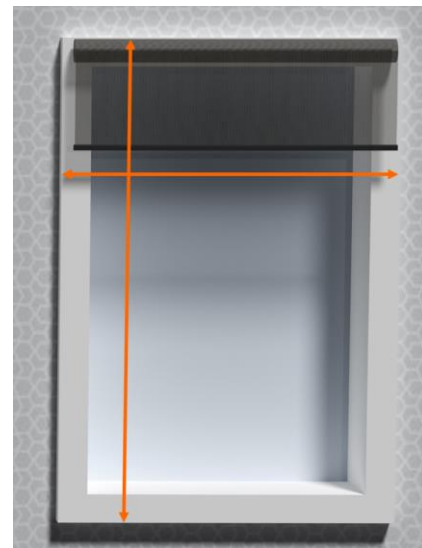

figure 4: measuring an outside fit blind – fixed to architrave

important note

Please take care when measuring your windows making sure that your measurements are accurate. If you make a mistake we may not be able to alter your blinds and may have to remake them. You will also have to pay for the cost of any remade blinds and possibly incur further freight charges.